

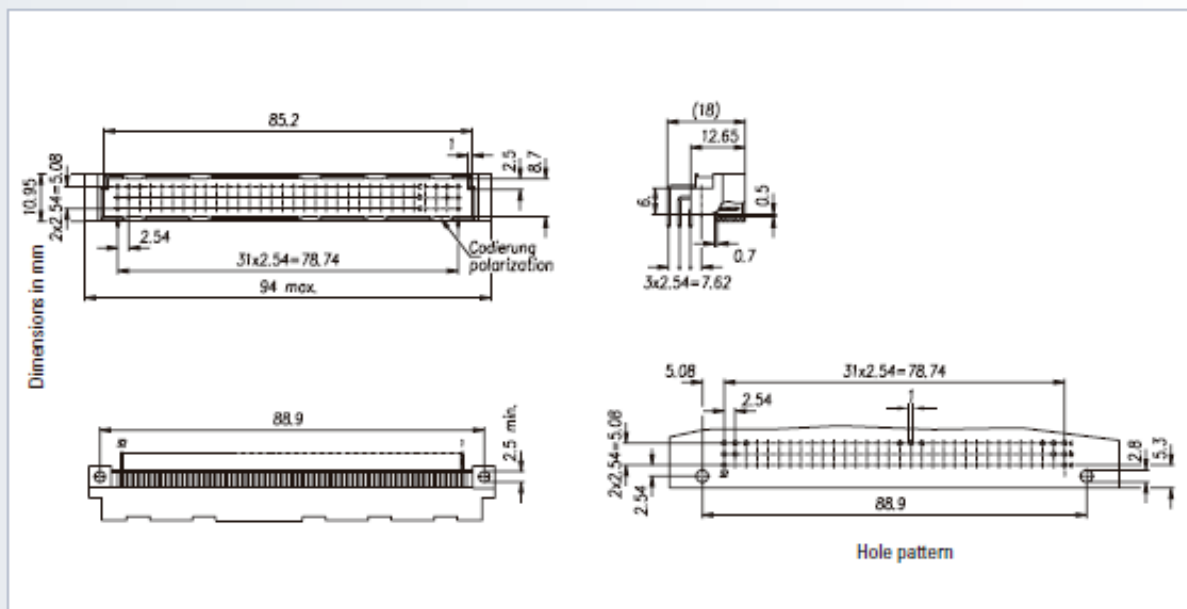







S.C.P. s.a.

Suministros de Conectores Profesionales, s.a.

103-40064



No. of contacts	Contact arrangement	Press-fit technology – Performance level II	
		Termination length	
			
		Part number	
32		103-60014	103-65015
48		103-60044	103-65045
64		103-60054	103-65055
96		103-60064	103-65065







Accessories <ul style="list-style-type: none"> – Press-fit tool (see page 206) – Support tool (see page 207) – Coding accessories (see page 160) 	On request <ul style="list-style-type: none"> – Performance levels I + III or customer-specific – Special contact length 	Options <ul style="list-style-type: none"> – Contact arrangement (see page 162)
Note <ul style="list-style-type: none"> – * Rear mating zone Ni, Au 		

Tel.: +34 91 355 60 06
e-mail: comercial@scp-sa.es



S.C.P. s.a.

Suministros de Conectores Profesionales, s.a.

No. of contacts	Contact arrangement	Solder technology – Performance level II		
		Termination length		
				
Part number				
32		103-40014	103-40015	103-40194
48		103-40024	103-40025	103-40144
64		103-40034	103-40035	103-40154
96		103-40064	103-40065	103-40174

Accessories – Coding accessories (see page 160)	On request – Performance levels I + III or customer-specific – Special contact length – Also in THTR	Options – Board lock (see page 159) – Contact arrangement (see page 162)
-----------------------------------------------------------	----------------------------------------------------------------------------------------------------------------------	---------------------------------------------------------------------------------------

Tel.: +34 91 355 60 06
 e-mail: comercial@scp-sa.es